



PRODUCT SHEET

**Harbour Column Counter/Bar Table**  
*by Norm Architects*

# Harbour Column Counter Table

BY NORM ARCHITECTS

Black powder coated aluminium and steel base with round or rectangular tabletop in Kunis Breccia stone, Estremoz marble, black painted oak or linoleum.



## PRODUCT OPTIONS

### TABLETOP



BLACK PAINTED OAK



CHARCOAL LINOLEUM



ESTREMOZ MARBLE



KUNIS BRECCIA STONE

### BASE



BLACK POWDER COATED ALUMINIUM & STEEL

# Harbour Column Counter Table

BY NORM ARCHITECTS

## TECHNICAL SPECIFICATIONS

### PRODUCT TYPE

Counter and bar table

### COLLI

1

### ENVIRONMENT

Indoor

### DIMENSIONS

#### 70 x 60

H: 93 cm / 36,6"

W: 70 cm / 27,6"

D: 60 cm / 23,6"

#### Ø60

H: 93 cm / 36,6"

Ø: 60 cm / 23,6"

#### Ø80

H: 93 cm / 36,6"

Ø: 80 cm / 31,5"

### PRODUCTION PROCESS

Both base and top plate for mounting the tabletop to the base are made from flame-cut steel. The column is made of extruded aluminium. Tabletops are CNC milled and Kunis Breccia stone and Estremoz marble versions are treated with a sealer.

### COLOUR

#### Tabletop

Black (RAL 9005)

Charcoal (RAL 7012)

Off white (Estremoz marble)

Sand (Kunis Breccia stone)

#### Base

Black (RAL 9005)

### GLOSS

Gloss 10-20

### MATERIALS

#### Tabletop

Kunis Breccia stone, Estremoz marble, MDF and forbo linoleum or MDF and painted oak veneer

#### Topplate

Powder coated steel

#### Base

Cast, extruded aluminium, steel

### WEIGHT

#### Tabletop oak or linoleum

Ø60: 8 kg / 17,6 lb

Ø80: 9 kg / 19,8 lb

70 x 60: 8,5 kg / 18,7 lb

#### Tabletop marble or stone

Ø60: 28 kg / 61,7 lb

Ø80: 52,8 kg / 116,4 lb

70 x 60: 36 kg / 79,4 lb

#### Topplate

6,4 kg / 14,1 lb

#### Column counter

3 kg / 6,6 lb

#### Base

Ø50: 12,9 kg / 28,4 lb

### TEST

EN 15372:2016, L2

### CERTIFICATIONS

TSCA title VI compliant

### PACKAGING TYPE

Brown box

### PACKAGING MEASUREMENTS (H x W x D)

#### Tabletop oak or linoleum 70 x 60

6 cm x 75 cm x 65 cm / 2,4" x 29,5" x 25,6"

#### Tabletop marble or stone 70 x 60

80 cm x 70 cm x 10 cm / 31,5" x 27,6" x 4"

#### Tabletop oak or linoleum Ø60

6 cm x 65 cm x 65 cm / 2,4" x 25,6" x 25,6"

#### Tabletop marble or stone Ø60

70 cm x 70 cm x 10 cm / 27,6" x 27,6" x 4"

#### Tabletop oak or linoleum Ø80

6 cm x 85 cm x 85 cm / 2,4" x 33,5" x 33,5"

#### Tabletop marble or stone Ø80

90 cm x 90 cm x 10 cm / 35,4" x 35,4" x 4"

#### Topplate Ø40

6 cm x 48 cm x 48 cm / 2,4" x 18,9" x 18,9"

#### Column counter (H x Ø)

105 cm x 7 cm / 41,3" x 2,8"

#### Base Ø50

6 cm x 58 cm x 58 cm / 2,4" x 22,8" x 22,8"

### MATERIALS & MAINTENANCE

Please visit [menuspace.com](https://www.menuspace.com) for materials, care and maintenance instructions.

# Harbour Column Counter Table

BY NORM ARCHITECTS

## TECHNICAL SPECIFICATIONS

70 X 60

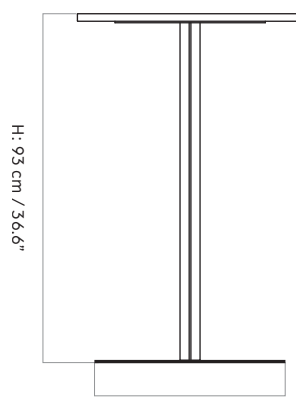
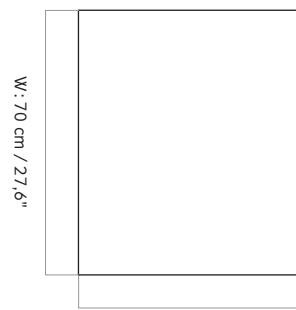

# Harbour Column Counter Table

BY NORM ARCHITECTS

## TECHNICAL SPECIFICATIONS

Ø60

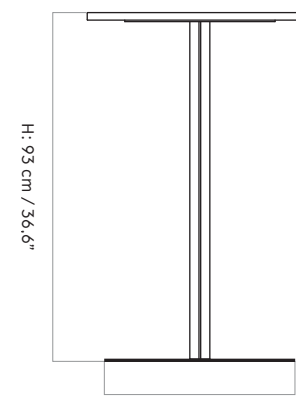
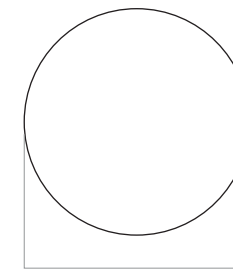

Ø80

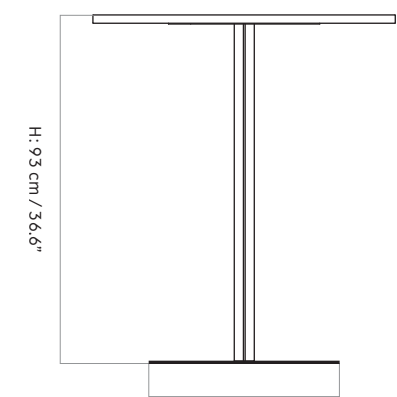
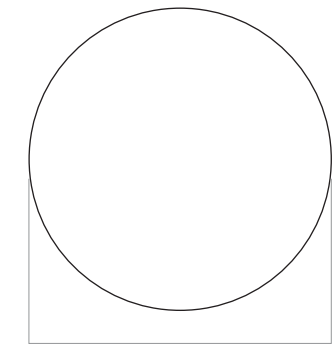

# Harbour Column Counter Table, Star Base

BY NORM ARCHITECTS

Star-shaped, black powder coated aluminium and steel base in with round or rectangular tabletop in Kunis Breccia stone, Estremoz marble, black painted oak or linoleum.



## PRODUCT OPTIONS

### TABLETOP



BLACK PAINTED OAK



CHARCOAL LINOLEUM



ESTREMOZ MARBLE

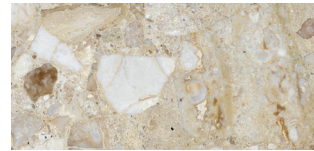

KUNIS BRECCIA STONE

### BASE



BLACK POWDER COATED ALUMINIUM & STEEL

# Harbour Column Counter Table, Star Base

BY NORM ARCHITECTS

## TECHNICAL SPECIFICATIONS

### PRODUCT TYPE

Counter and bar table

### COLLI

1

### ENVIRONMENT

Indoor

### DIMENSIONS

#### 70 x 60

H: 93 cm / 36,6"

W: 70 cm / 27,6"

D: 60 cm / 23,6"

#### Ø60

H: 93 cm / 36,6"

Ø: 60 cm / 23,6"

#### Ø80

H: 93 cm / 36,6"

Ø: 80 cm / 31,5"

### PRODUCTION PROCESS

Star base is made of die casted aluminium and column is made of extruded aluminium. The top plate for mounting the tabletop to the base is made from flame cut steel. The tabletops are CNC milled. The tabletop in Kunis Breccia stone and Estremoz marble is treated with a sealer.

### COLOUR

#### Tabletop

Black (RAL 9005)

Charcoal (RAL 7012)

Off white (Estremoz marble)

Sand (Kunis Breccia stone)

#### Base

Black (RAL 9005)

### GLOSS

Gloss 10,20

### MATERIALS

#### Tabletop

Kunis Ereccia stone, Estremoz marble, MDF and forbo linoleum or MDF and painted oak veneer

#### Topplate

Powder coated steel

#### Base

Cast, extruded aluminium, steel

### WEIGHT

#### Tabletop oak or linoleum

Ø60: 8 kg / 17,6 lb

Ø80: 9 kg / 19,8 lb

70 x 60: 8,5 kg / 18,7 lb

#### Tabletop marble or stone

Ø60: 28 kg / 61,7 lb

Ø80: 52,8 kg / 116,4 lb

70 x 60: 36 kg / 79,4 lb

#### Topplate

6,4 kg / 14,1 lb

#### Column counter

2,5 kg / 5,5 lb

#### Star base

3,5 kg / 7,7 lb

### TEST

EN 15372:2016, L2

### CERTIFICATIONS

TSCA title VI compliant

### PACKAGING TYPE

Brown box

### PACKAGING MEASUREMENTS (H x W x D)

#### Tabletop oak or linoleum 70 x 60

6 cm x 75 cm x 65 cm / 2,4" x 29,5" x 25,6"

#### Tabletop marble or stone 70 x 60

80 cm x 70 cm x 10 cm / 31,5" x 27,6" x 4"z

#### Tabletop oak or linoleum Ø60

6 cm x 65 cm x 65 cm / 2,4" x 25,6" x 25,6"

#### Tabletop marble or stone Ø60

70 cm x 70 cm x 10 cm / 27,6" x 27,6" x 4"

#### Tabletop oak or linoleum Ø80

6 cm x 85 cm x 85 cm / 2,4" x 33,5" x 33,5"

#### Tabletop marble or stone Ø80

90 cm x 90 cm x 10 cm / 35,4" x 35,4" x 4"

#### Topplate

6 cm x 48 cm x 48 cm / 2,4" x 18,9" x 18,9"

#### Column counter (H x Ø)

75 cm x 7 cm / 29,5" x 2,8"

#### Star base

22 cm x 51 cm x 51 cm / 8,7" x 20,1" x 20,1"

### MATERIALS & MAINTENANCE

Please visit [menuspace.com](https://www.menuspace.com) for materials, care and maintenance instructions.

# Harbour Column Counter Table, Star Base

BY NORM ARCHITECTS

## TECHNICAL SPECIFICATIONS

70 X 60

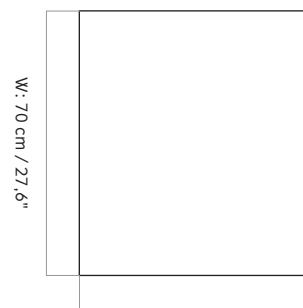

W: 70 cm / 27,6"

D: 60 cm / 23,6"

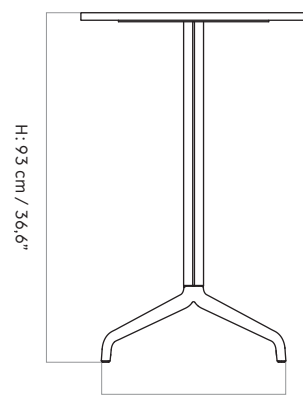

H: 93 cm / 36,6"

D/W: 49 cm / 19,3"

# Harbour Column Counter Table, Star Base

BY NORM ARCHITECTS

## TECHNICAL SPECIFICATIONS

Ø60

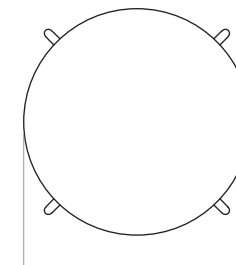

Ø: 60 cm / 23,6"

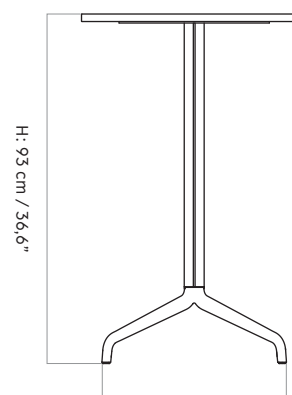

H: 93 cm / 36,6"

D/W: 49 cm / 19,3"

Ø80

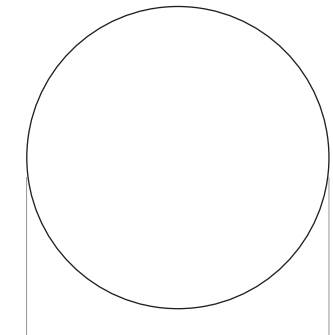

Ø: 80 cm / 31,5"

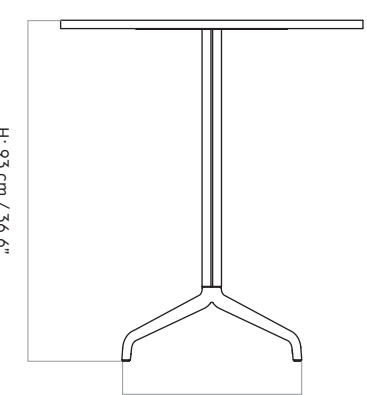

H: 93 cm / 36,6"

D/W: 49 cm / 19,3"

# Harbour Column Bar Table

BY NORM ARCHITECTS

Black powder coated aluminium and steel base with round or rectangular tabletop in Kunis Breccia stone, Estremoz marble, black painted oak or linoleum.



## PRODUCT OPTIONS

### TABLETOP



BLACK PAINTED OAK



CHARCOAL LINOLEUM



ESTREMOZ MARBLE



KUNIS BRECCIA STONE

### BASE



BLACK POWDER COATED ALUMINIUM & STEEL

# Harbour Column Bar Table

BY NORM ARCHITECTS

## TECHNICAL SPECIFICATIONS

### PRODUCT TYPE

Counter and bar table

### COLLI

1

### ENVIRONMENT

Indoor

### DIMENSIONS

#### 70 x 60

H: 103 cm / 40,6"

W: 70 cm / 27,6"

D: 60 cm / 23,6"

#### Ø60

H: 103 cm / 40,6"

Ø: 60 cm / 23,6"

#### Ø80

H: 103 cm / 40,6"

Ø: 80 cm / 31,5"

### PRODUCTION PROCESS

Both base and top plate for mounting the tabletop to the base are made from flame-cut steel. The column is made of extruded aluminium. Tabletops are CNC milled and Kunis Breccia stone and Estremoz marble versions are treated with a sealer.

### COLOUR

#### Tabletop

Black (RAL 9005)

Charcoal (RAL 7012)

Off white (Estremoz marble)

Sand (Kunis Breccia stone)

#### Base

Black (RAL 9005)

### GLOSS

Gloss 10-20

### MATERIALS

#### Tabletop

Kunis Breccia stone, Estremoz marble, MDF and forbo linoleum or MDF and painted oak veneer

#### Topplate

Powder coated steel

#### Base

Cast, extruded aluminium, steel

### WEIGHT

#### Tabletop oak or linoleum

Ø60: 8 kg / 17,6 lb

Ø80: 9 kg / 19,8 lb

70 x 60: 8,5 kg / 18,7 lb

#### Tabletop marble or stone

Ø60: 28 kg / 61,7 lb

Ø80: 52,8 kg / 116,4 lb

70 x 60: 36 kg / 79,4 lb

#### Topplate

6,4 kg / 14,1 lb

#### Column bar

3,3 kg / 7,3 lb

#### Base

Ø50: 12,9 kg / 28,4 lb

### TEST

EN 15372:2016, L2

### CERTIFICATIONS

TSCA title VI compliant

### PACKAGING TYPE

Brown box

### PACKAGING MEASUREMENTS (H x W x D)

#### Tabletop oak or linoleum 70 x 60

6 cm x 75 cm x 65 cm / 2,4" x 29,5" x 25,6"

#### Tabletop marble or stone 70 x 60

80 cm x 70 cm x 10 cm / 31,5" x 27,6" x 4"

#### Tabletop oak or linoleum Ø60

6 cm x 65 cm x 65 cm / 2,4" x 25,6" x 25,6"

#### Tabletop marble or stone Ø60

70 cm x 70 cm x 10 cm / 27,6" x 27,6" x 4"

#### Tabletop oak or linoleum Ø80

6 cm x 85 cm x 85 cm / 2,4" x 33,5" x 33,5"

#### Tabletop marble or stone Ø80

90 cm x 90 cm x 10 cm / 35,4" x 35,4" x 4"

#### Topplate Ø40

6 cm x 48 cm x 48 cm / 2,4" x 18,9" x 18,9"

#### Column bar (H x Ø)

105 cm x 7 cm / 41,3" x 2,8"

#### Base Ø50

6 cm x 58 cm x 58 cm / 2,4" x 22,8" x 22,8"

### MATERIALS & MAINTENANCE

Please visit [menuspace.com](https://www.menuspace.com) for materials, care and maintenance instructions.

# Harbour Column Bar Table

BY NORM ARCHITECTS

## TECHNICAL SPECIFICATIONS

70 X 60

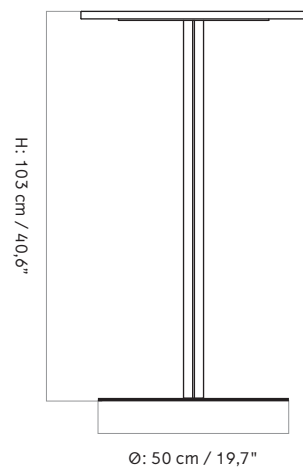
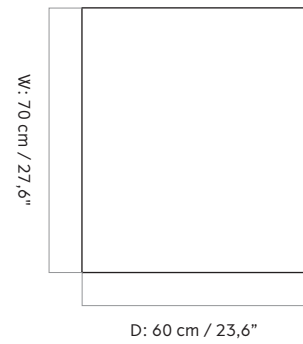

# Harbour Column Bar Table

BY NORM ARCHITECTS

Ø60

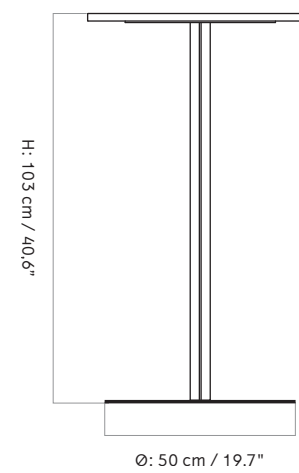
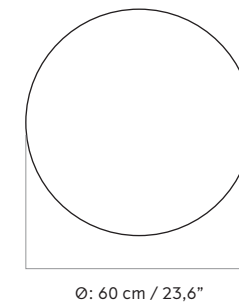

Ø80

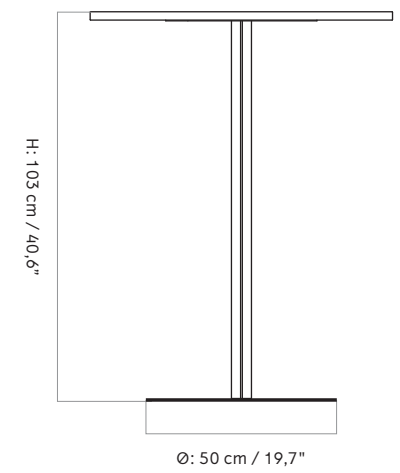
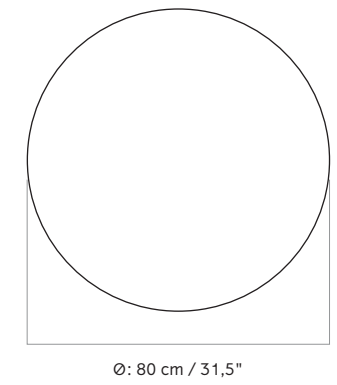

# Harbour Column Bar Table, Star Base

BY NORM ARCHITECTS

Star-shaped, black powder coated aluminium and steel base in with round or rectangular tabletop in Kunis Breccia stone, Estremoz marble, black painted oak or linoleum.



## PRODUCT OPTIONS

### TABLETOP



BLACK PAINTED OAK



CHARCOAL LINOLEUM



ESTREMOZ MARBLE



KUNIS BRECCIA STONE

### BASE



BLACK POWDER COATED ALUMINIUM & STEEL

# Harbour Column Bar Table, Star Base

BY NORM ARCHITECTS

## TECHNICAL SPECIFICATIONS

### PRODUCT TYPE

Counter and bar table

### COLLI

1

### ENVIRONMENT

Indoor

### DIMENSIONS

#### 70 x 60

H: 103 cm / 40,6"

W: 70 cm / 27,6"

D: 60 cm / 23,6"

#### Ø60

H: 103 cm / 40,6"

Ø: 60 cm / 23,6"

#### Ø90

H: 103 cm / 40,6"

Ø: 80 cm / 31,5"

### PRODUCTION PROCESS

Star base is made of die casted aluminium and column is made of extruded aluminium. The top plate for mounting the tabletop to the base is made from flame cut steel. The tabletops are CNC milled. The tabletop in Kunis Breccia stone and Estremoz marble is treated with a sealer.

### COLOUR

#### Tabletop

Black (RAL 9005)

Charcoal (RAL 7012)

Off white (Estremoz marble)

Sand (Kunis Breccia stone)

#### Base

Black (RAL 9005)

### GLOSS

Gloss 10,20

### MATERIALS

#### Tabletop

Kunis Ereccia stone, Estremoz marble, MDF and forbo linoleum or MDF and painted oak veneer

#### Topplate

Powder coated steel

#### Base

Cast, extruded aluminium, steel

### WEIGHT

#### Tabletop oak or linoleum

Ø60: 8 kg / 17,6 lb

Ø80: 9 kg / 19,8 lb

70 x 60: 8,5 kg / 18,7 lb

#### Tabletop marble or stone

Ø60: 28 kg / 61,7 lb

Ø80: 52,8 kg / 116,4 lb

70 x 60: 36 kg / 79,4 lb

#### Topplate

6,4 kg / 14,1 lb

#### Column bar

2,8 kg / 6,2 lb

#### Star base

3,5 kg / 7,7 lb

### TEST

EN 15372:2016, L2

### CERTIFICATIONS

TSCA title VI compliant

### PACKAGING TYPE

Brown box

### PACKAGING MEASUREMENTS (H x W x D)

#### Tabletop oak or linoleum 70 x 60

6 cm x 75 cm x 65 cm / 2,4" x 29,5" x 25,6"

#### Tabletop marble or stone 70 x 60

80 cm x 70 cm x 10 cm / 31,5" x 27,6" x 4"z

#### Tabletop oak or linoleum Ø60

6 cm x 65 cm x 65 cm / 2,4" x 25,6" x 25,6"

#### Tabletop marble or stone Ø60

70 cm x 70 cm x 10 cm / 27,6" x 27,6" x 4"

#### Tabletop oak or linoleum Ø80

6 cm x 85 cm x 85 cm / 2,4" x 33,5" x 33,5"

#### Tabletop marble or stone Ø80

90 cm x 90 cm x 10 cm / 35,4" x 35,4" x 4"

#### Topplate

6 cm x 48 cm x 48 cm / 2,4" x 18,9" x 18,9"

#### Column bar (H x Ø)

105 cm x 7 cm / 21,7" x 2,8"

#### Star base

22 cm x 51 cm x 51 cm / 8,7" x 20,1" x 20,1"

### MATERIALS & MAINTENANCE

Please visit [menuspace.com](https://www.menuspace.com) for materials, care and maintenance instructions.



# Harbour Column Bar Table, Star Base

BY NORM ARCHITECTS

## TECHNICAL SPECIFICATIONS

70 X 60

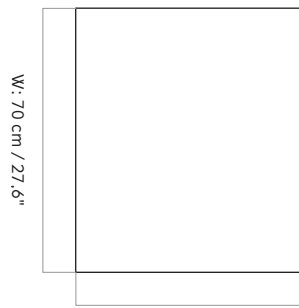

D: 60 cm / 23,6"

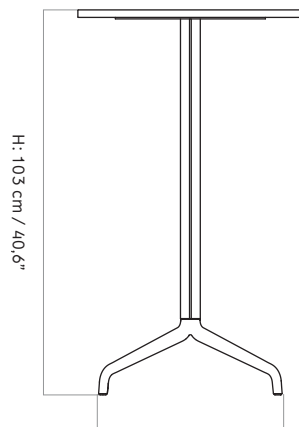

D/W: 49 cm / 19,3"

# Harbour Column Bar Table, Star Base

BY NORM ARCHITECTS

## TECHNICAL SPECIFICATIONS

Ø60

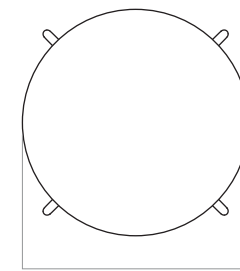

Ø: 60 cm / 23,6"

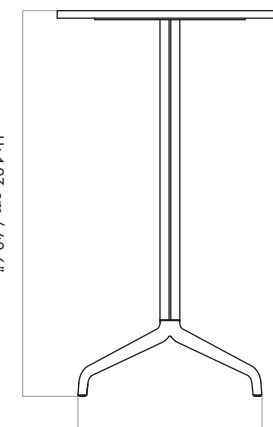

D/W: 49 cm / 19,3"

Ø80

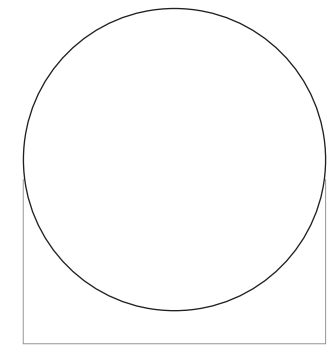

Ø: 80 cm / 31,5"

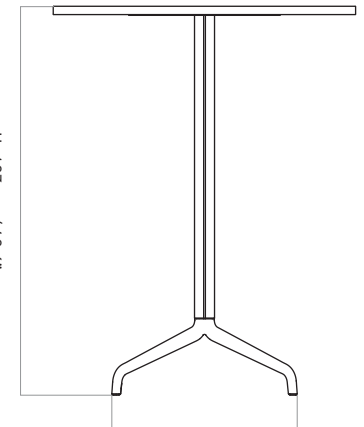

D/W: 49 cm / 19,3"