

Ethnicraft

RIBBON

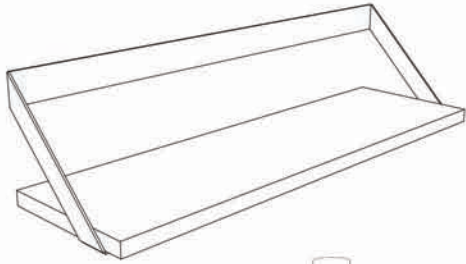

25kg
MAXIMUM LOAD

ASSEMBLY INSTRUCTIONS

Ethnicraft

RIBBON

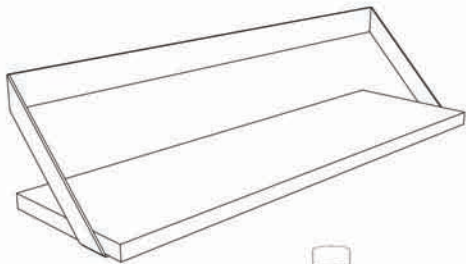

25kg
MAXIMUM LOAD

ASSEMBLY INSTRUCTIONS

HARDWARE (included in package)

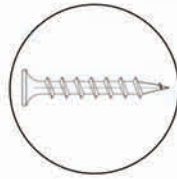

Wall screw f5x50 - 2pcs

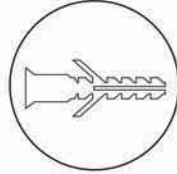

Wall plug 08x40 - 2pcs

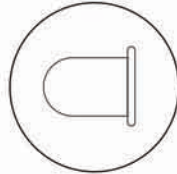

Silicon bumper - 4pcs

Tools (NOT included in package)

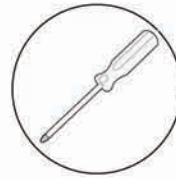

Screwdriver

Drill machine



Pencil

Leveler

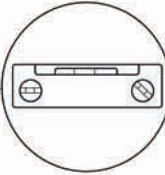

2.

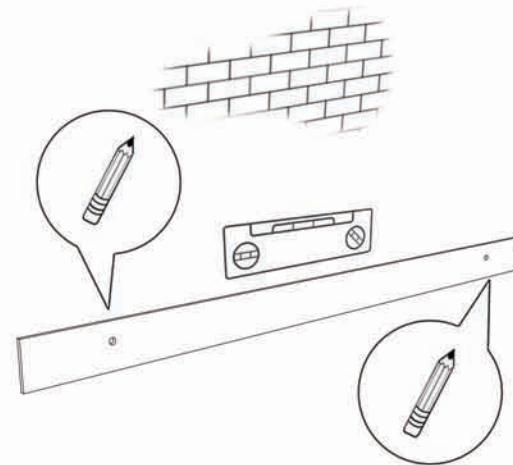

- Place the stencil (stencil is included in packaging) on the wall and mark the position of the holes
- Use leveler to find horizontal

3.

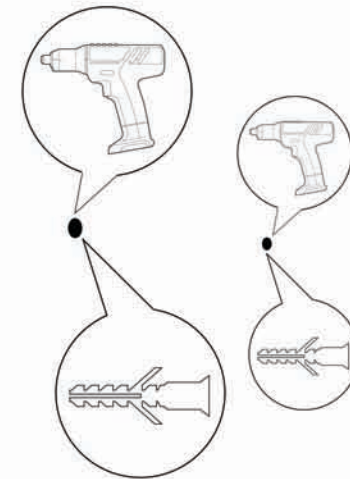

- Drill the marked holes
- Insert wall plugs

1.

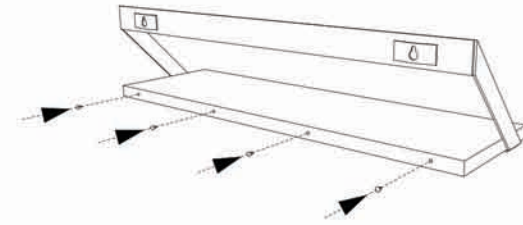

- Insert the silicon bumpers in to the wooden shelf

4.

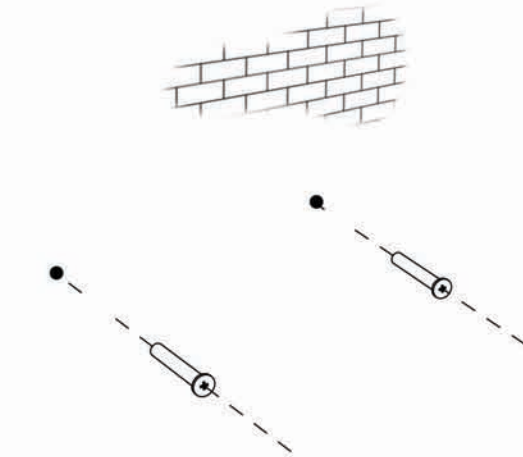

- Insert the wall screws into the wall plugs

5.

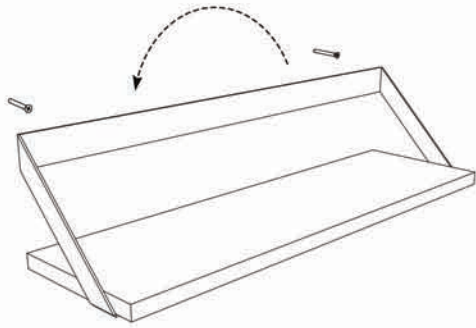

6.

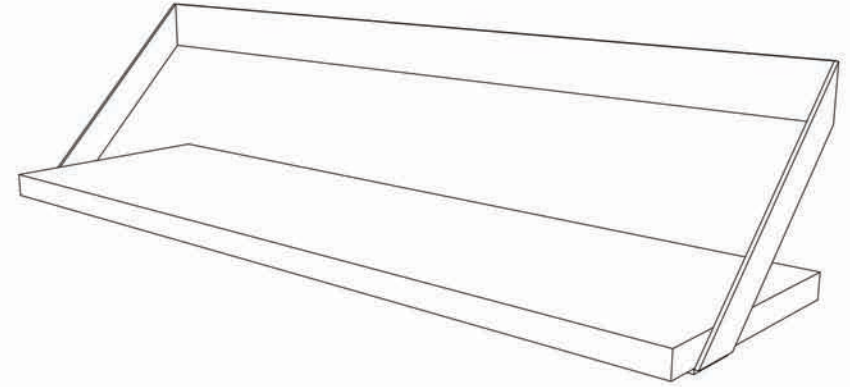
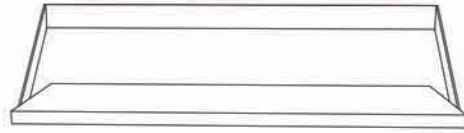

- Hang assembly on the wall screws

- Assembled product